

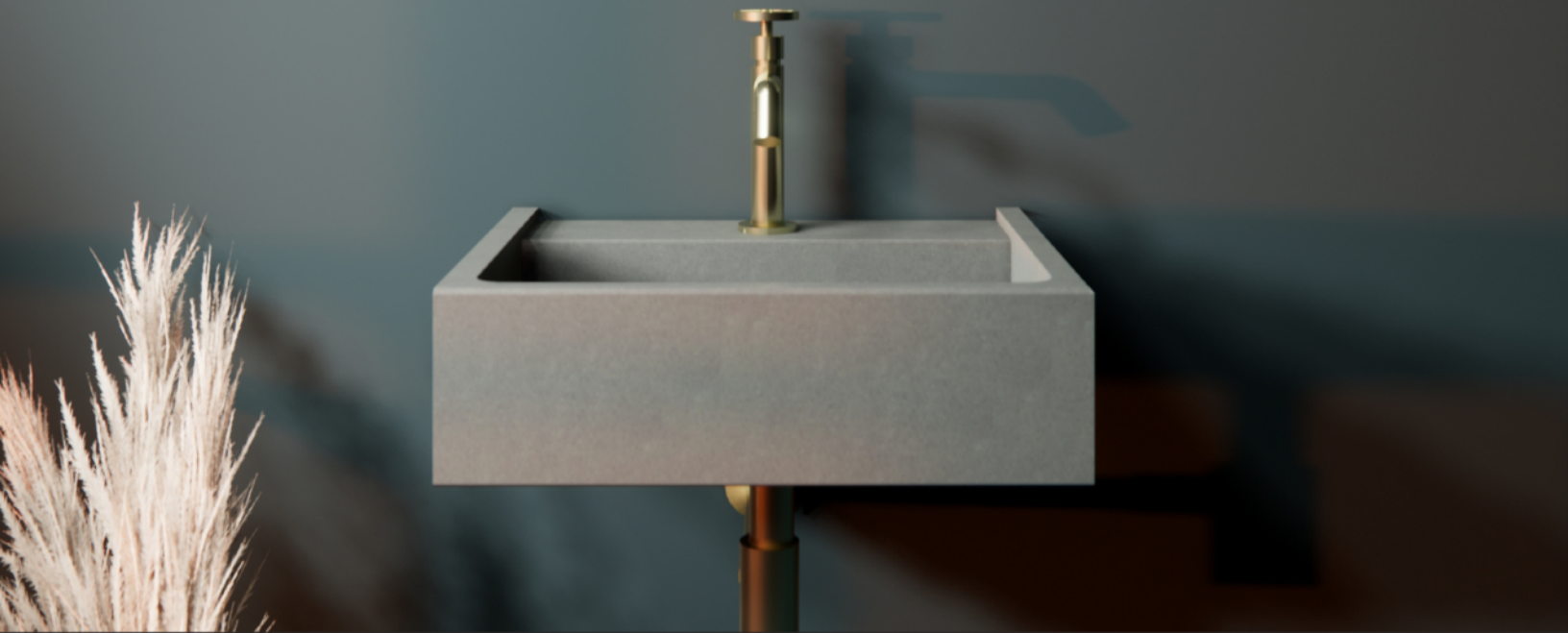

B A L U X

PRICE LIST
2026

USA

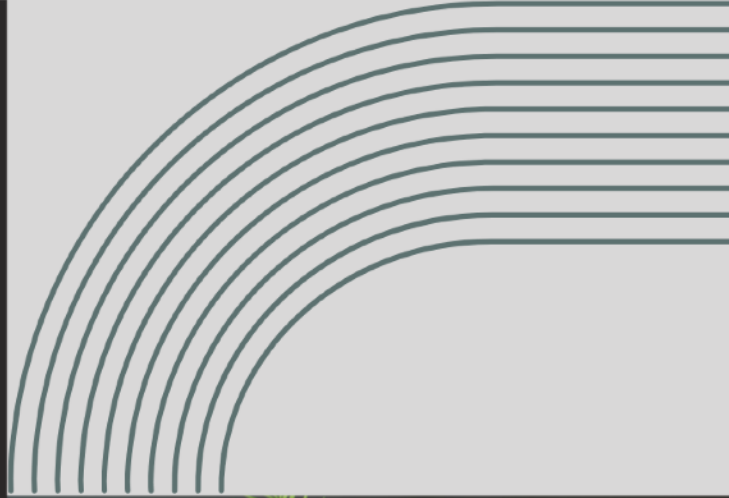

**SINKS-VESSELS – SHOWER BASES
BATHTUBS – TILES**

THE ENDLESS POSSIBILITIES OF CONCRETE

WWW.BALUX.CA

update: February 2026

INDEX

| | |
|--|----|
| FLO | 3 |
| BALI | 4 |
| LATUS | 5 |
| TALCA | 6 |
| LOFT | 7 |
| OVO | 8 |
| VOLTO, KANTO | 9 |
| TALI, VICTORIA | 10 |
| LIAM, CYLO | 11 |
| OSLO | 12 |
| WALL MOUNTED BASINS | 13 |
| SHOWER BASES | 14 |
| BATH TUBS | 15 |
| OTHER PRODUCTS | 18 |
| SHIPPING ZONE | 19 |
| COLOR CHART | 20 |
| BRACKETS INSTALLATION GUIDE (BRAQ16) | 22 |
| WARRANTY | 23 |
| CONTACT | 24 |

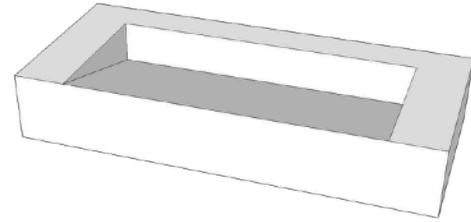

List pricing

| Thickness of facade | | | | | | | | | | |
|---------------------|---|----------|------------|----------|---------------|----------|------------|----------|---------------|----------|
| LENGTH | 1" | | 2" | | 4" | | 6" | | 8" | |
| | Types of finishes (terrazzo = exterior only) | | | | | | | | | |
| | Color | Terrazzo | Color | Terrazzo | Color | Terrazzo | Color | Terrazzo | Color | Terrazzo |
| * 28"-36" | 2306 | 2564 | 2392 | 2660 | 2482 | 2760 | 2575 | 2864 | 2672 | 2971 |
| 37"-48" | 2553 | 2839 | 2649 | 2945 | 2748 | 3056 | 2851 | 3170 | 2958 | 3289 |
| 49"-60" | 2680 | 2980 | 2781 | 3092 | 2885 | 3208 | 2993 | 3328 | 3105 | 3453 |
| 61"-72" | 3042 | 3383 | 3156 | 3510 | 3274 | 3641 | 3397 | 3778 | 3525 | 3919 |
| 73"-84" | 3289 | 3657 | 3412 | 3795 | 3540 | 3937 | 3673 | 4084 | 3811 | 4238 |
| 85"-96" | 3537 | 3933 | 3670 | 4081 | 3807 | 4234 | 3950 | 4392 | 4098 | 4557 |
| Approximate weight | 10 lb/sqft | | 12 lb/sqft | | 13,50 lb/sqft | | 18 lb/sqft | | 20,50 lb/sqft | |
| | Take length and depth to calculate square feet. For example, a 48' x 21 1/2" counter-sink = 7.17 sqft x 18 lb (6") = 129 lb total | | | | | | | | | |

* smaller size available upon request

STANDARD BASIN OPTIONS

| | | | | | | |
|---------------------------|--------------------------|-------------------------|--------------------------|--------------------------|-------------------------|--------------------------|
| A - 20" x 17" x 5" | B- 24" x 17" x 5" | C- 30" x 17"x 5" | D- 36" x 17' x 5" | E- 42" x 17" x 5" | F- 48" x17" x 5" | G- 60" x 17" x 5" |
|---------------------------|--------------------------|-------------------------|--------------------------|--------------------------|-------------------------|--------------------------|

Validate depth of counter space depending on faucets

| | | | |
|--|---------------------------------|-----------------------|---|
| Wall mounted : | Basin 17" + 3" back = 20" total | Deck mounted : | Basin 17" + 4 1/2" back = 21 1/2" total |
| For any other depth or dimensions please contact us at : info@balux.ca | | | |

| OPTIONAL | | |
|---|---------------|----------------------|
| BRACKETS for floating sinks (UNIT) min. 2 per vanity | BRAQ16 | 105,00 \$ |
| EXTRA BASIN | CUV2 | 300,00 \$ |
| CUSTOM BASIN | CUST | + 50% OF TOTAL PRICE |
| CUSTOM COLOR | 999 | 275,00 \$ |
| FLUTED DESIGN | FLUT | 475,00 \$ |
| RIBBED DESIGN | RIBB | 475,00 \$ |
| ROUND CORNER | ROUND | 250,00 \$ EACH |
| SHIPPING PRICE Refer to chart, or contact us info@balux.ca | | |

| REQUIRED Net pricing DELIVERY TO THE STORE ONLY | | | |
|--|--------|--------|--------|
| SHIPPING & HANDLING FEES * refer to page 19 for zone information | | | |
| SIZE OF ITEM | ZONE 1 | ZONE 2 | ZONE 3 |
| 36 inches and less | 425 \$ | 525 \$ | 625 \$ |
| 36-96 inches | 495 \$ | 595 \$ | 695 \$ |
| Shipping of the brackets first | 50 \$ | 50 \$ | 75 \$ |
| Prices for single item orders, for orders of 2 items or more please contact info@balux.ca | | | |

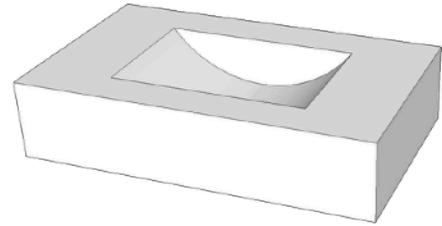

List pricing

| Thickness of facade | | | | | | | | | | |
|---------------------|---|----------|------------|----------|---------------|----------|------------|----------|---------------|----------|
| LENGTH | 1" | | 2" | | 4" | | 6" | | 8" | |
| | Types of finishes (terrazzo = exterior only) | | | | | | | | | |
| | Color | Terrazzo | Color | Terrazzo | Color | Terrazzo | Color | Terrazzo | Color | Terrazzo |
| * 28"-36" | 2306 | 2564 | 2392 | 2660 | 2482 | 2760 | 2575 | 2864 | 2672 | 2971 |
| 37"-48" | 2553 | 2839 | 2649 | 2945 | 2748 | 3056 | 2851 | 3170 | 2958 | 3289 |
| 49"-60" | 2680 | 2980 | 2781 | 3092 | 2885 | 3208 | 2993 | 3328 | 3105 | 3453 |
| 61"-72" | 3042 | 3383 | 3156 | 3510 | 3274 | 3641 | 3397 | 3778 | 3525 | 3919 |
| 73"-84" | 3289 | 3657 | 3412 | 3795 | 3540 | 3937 | 3673 | 4084 | 3811 | 4238 |
| 85"-96" | 3537 | 3933 | 3670 | 4081 | 3807 | 4234 | 3950 | 4392 | 4098 | 4557 |
| Approximate weight | 10 lb/sqft | | 12 lb/sqft | | 13,50 lb/sqft | | 18 lb/sqft | | 20,50 lb/sqft | |
| | Take length and depth to calculate square feet. For example, a 48' x 21 1/2" counter-sink = 7.17 sqft x 18 lb (6") = 129 lb total | | | | | | | | | |

* smaller size available upon request

STANDARD BASIN OPTIONS

| | | | | | | |
|------------------------|-----------------------|-----------------------|-----------------------|-----------------------|-----------------------|-----------------------|
| A - 20" x 13 1/2" x 5" | B- 24" x 13 1/2" x 5" | C- 30" x 13 1/2" x 5" | D- 36" x 13 1/2" x 5" | E- 42" x 13 1/2" x 5" | F- 48" x 13 1/2" x 5" | G- 60" x 13 1/2" x 5" |
|------------------------|-----------------------|-----------------------|-----------------------|-----------------------|-----------------------|-----------------------|

Validate depth of counter space depending on faucets

| | | | |
|---------------------|--|---------------------|--|
| Wall mounted | Basin 13 1/2" + 2" back + 3 1/2" front = 19" total | Deck mounted | Basin 13 1/2" + 4 1/2" back + 3 1/2" front = 21 1/2" total |
|---------------------|--|---------------------|--|

For any other depth or dimensions please contact us at : info@balux.ca

OPTIONAL

| | | |
|--|------------------|----------------------|
| BRACKETS for floating sinks (UNIT) min. 2 per vanity | BRAQ16 | 105,00 \$ |
| EXTRA BASIN | CUV2 | 300,00 \$ |
| CUSTOM BASIN | CUST | + 50% OF TOTAL PRICE |
| CUSTOM COLOR | 999 | 275,00 \$ |
| FLUTED DESIGN | FLUT | 475,00 \$ |
| RIBBED DESIGN | RIBB | 475,00 \$ |
| ROUND CORNER | ROUND | 250,00\$ EACH |
| CONCRETE DRAIN | DRBET-xxx | 295,00 \$ |

SHIPPING PRICE Refer to chart, or contact us info@balux.ca

REQUIRED Net pricing DELIVERY TO THE STORE ONLY

SHIPPING & HANDLING FEES * refer to page 19 for zone information

| SIZE OF ITEM | ZONE 1 | ZONE 2 | ZONE 3 |
|--------------------------------|--------|--------|--------|
| 36 inches and less | 425 \$ | 525 \$ | 625 \$ |
| 36-96 inches | 495 \$ | 595 \$ | 695 \$ |
| Shipping of the brackets first | 50 \$ | 50 \$ | 75 \$ |

Prices for single item orders, for orders of 2 items or more please contact info@balux.ca

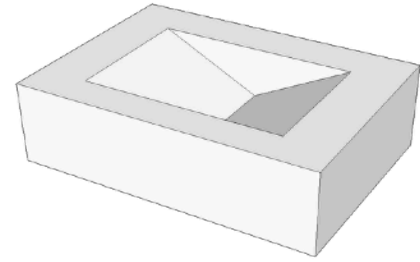

List pricing

| Thickness of facade | | | | | | | | | | |
|---------------------|---|----------|------------|----------|---------------|----------|------------|----------|---------------|----------|
| LENGTH | 1" | | 2" | | 4" | | 6" | | 8" | |
| | Types of finishes (terrazzo = exterior only) | | | | | | | | | |
| | Color | Terrazzo | Color | Terrazzo | Color | Terrazzo | Color | Terrazzo | Color | Terrazzo |
| * 28"-36" | 2306 | 2564 | 2392 | 2660 | 2482 | 2760 | 2575 | 2864 | 2672 | 2971 |
| 37"-48" | 2553 | 2839 | 2649 | 2945 | 2748 | 3056 | 2851 | 3170 | 2958 | 3289 |
| 49"-60" | 2680 | 2980 | 2781 | 3092 | 2885 | 3208 | 2993 | 3328 | 3105 | 3453 |
| 61"-72" | 3042 | 3383 | 3156 | 3510 | 3274 | 3641 | 3397 | 3778 | 3525 | 3919 |
| 73"-84" | 3289 | 3657 | 3412 | 3795 | 3540 | 3937 | 3673 | 4084 | 3811 | 4238 |
| 85"-96" | 3537 | 3933 | 3670 | 4081 | 3807 | 4234 | 3950 | 4392 | 4098 | 4557 |
| Approximate weight | 10 lb/sqft | | 12 lb/sqft | | 13,50 lb/sqft | | 18 lb/sqft | | 20,50 lb/sqft | |
| | Take length and depth to calculate square feet. For example, a 48' x 21 1/2" counter-sink = 7.17 sqft x 18 lb (6") = 129 lb total | | | | | | | | | |

* smaller size available upon request

STANDARD BASIN OPTIONS

| | | | | | | |
|-------------------------------|------------------------------|------------------------------|------------------------------|------------------------------|------------------------------|------------------------------|
| A - 20" x 13 1/2" x 5" | B- 24" x 13 1/2" x 5" | C- 30" x 13 1/2" x 5" | D- 36" x 13 1/2" x 5" | E- 42" x 13 1/2" x 5" | F- 48" x 13 1/2" x 5" | G- 60" x 13 1/2" x 5" |
|-------------------------------|------------------------------|------------------------------|------------------------------|------------------------------|------------------------------|------------------------------|

Validate depth of counter space depending on faucets

| | | | |
|---------------------|--|---------------------|--|
| Wall mounted | Basin 13 1/2" + 2" back + 3 1/2" front = 19" total | Deck mounted | Basin 13 1/2" + 4 1/2" back + 3 1/2" front = 21 1/2" total |
|---------------------|--|---------------------|--|

For any other depth or dimensions please contact us at : info@balux.ca

OPTIONAL

| | | |
|---|---------------|----------------------|
| BRACKETS for floating sinks (UNIT) min. 2 per vanity | BRAQ16 | 105,00 \$ |
| EXTRA BASIN | CUV2 | 300,00 \$ |
| CUSTOM BASIN | CUST | + 50% OF TOTAL PRICE |
| CUSTOM COLOR | 999 | 275,00 \$ |
| FLUTED DESIGN | FLUT | 475,00 \$ |
| RIBBED DESIGN | RIBB | 475,00 \$ |
| ROUND CORNER | ROUND | 250,00\$ EACH |
| SHIPPING PRICE Refer to chart, or contact us info@balux.ca | | |

REQUIRED Net pricing DELIVERY TO THE STORE ONLY

SHIPPING & HANDLING FEES * refer to page 19 for zone information

| SIZE OF ITEM | ZONE 1 | ZONE 2 | ZONE 3 |
|--------------------------------|--------|--------|--------|
| 36 inches and less | 425 \$ | 525 \$ | 625 \$ |
| 36-96 inches | 495 \$ | 595 \$ | 695 \$ |
| Shipping of the brackets first | 50 \$ | 50 \$ | 75 \$ |

Prices for single item orders, for orders of 2 items or more please contact info@balux.ca

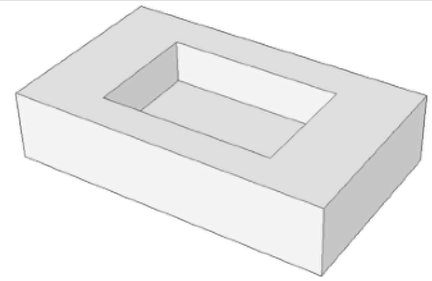

List pricing

Thickness of facade

| LENGTH | Thickness of facade | | | | | | | | | |
|--------------------|---|----------|------------|----------|---------------|----------|------------|----------|---------------|----------|
| | 1" | | 2" | | 4" | | 6" | | 8" | |
| | Types of finishes (terrazzo = exterior only) | | | | | | | | | |
| | Color | Terrazzo | Color | Terrazzo | Color | Terrazzo | Color | Terrazzo | Color | Terrazzo |
| * 28"-36" | 2306 | 2564 | 2392 | 2660 | 2482 | 2760 | 2575 | 2864 | 2672 | 2971 |
| 37"-48" | 2553 | 2839 | 2649 | 2945 | 2748 | 3056 | 2851 | 3170 | 2958 | 3289 |
| 49"-60" | 2680 | 2980 | 2781 | 3092 | 2885 | 3208 | 2993 | 3328 | 3105 | 3453 |
| 61"-72" | 3042 | 3383 | 3156 | 3510 | 3274 | 3641 | 3397 | 3778 | 3525 | 3919 |
| 73"-84" | 3289 | 3657 | 3412 | 3795 | 3540 | 3937 | 3673 | 4084 | 3811 | 4238 |
| 85"-96" | 3537 | 3933 | 3670 | 4081 | 3807 | 4234 | 3950 | 4392 | 4098 | 4557 |
| Approximate weight | 10 lb/sqft | | 12 lb/sqft | | 13,50 lb/sqft | | 18 lb/sqft | | 20,50 lb/sqft | |
| | Take length and depth to calculate square feet. For example, a 48' x 21 1/2" counter-sink = 7.17 sqft x 18 lb (6") = 129 lb total | | | | | | | | | |

* smaller size available upon request

STANDARD BASIN OPTIONS

| | | | | | | |
|------------------------|-----------------------|-----------------------|-----------------------|-----------------------|-----------------------|-----------------------|
| A - 20" x 13 1/2" x 5" | B- 24" x 13 1/2" x 5" | C- 30" x 13 1/2" x 5" | D- 36" x 13 1/2" x 5" | E- 42" x 13 1/2" x 5" | F- 48" x 13 1/2" x 5" | G- 60" x 13 1/2" x 5" |
|------------------------|-----------------------|-----------------------|-----------------------|-----------------------|-----------------------|-----------------------|

Validate depth of counter space depending on faucets

| | | | |
|---------------------|--|---------------------|--|
| Wall mounted | Basin 13 1/2" + 2" back + 3/2" front = 19" total | Deck mounted | Basin 13 1/2" + 4 1/2" back + 3/2" front = 21 1/2" total |
|---------------------|--|---------------------|--|

For any other depth or dimensions please contact us at : info@balux.ca

OPTIONAL

| | | |
|---|------------------|----------------------|
| BRACKETS for floating sinks (UNIT) min. 2 per vanity | BRAQ16 | 105,00 \$ |
| SMOOTH PANEL | TAL-xxx | 0 \$ |
| EXTRA BASIN | CUV2 | 300,00 \$ |
| CUSTOM BASIN | CUST | + 50% OF TOTAL PRICE |
| CUSTOM COLOR | 999 | 275,00 |
| FLUTED DESIGN | FLUT | 475,00 \$ |
| RIBBED DESIGN | RIBB | 475,00 \$ |
| ROUND CORNER | ROUND | 250,00\$ EACH |
| CONCRETE DRAIN | DRBET-xxx | 295,00 \$ |
| SHIPPING PRICE Refer to chart, or contact us info@balux.ca | | |

REQUIRED Net pricing DELIVERY TO THE STORE ONLY

SHIPPING & HANDLING FEES * refer to page 19 for zone information

| SIZE OF ITEM | ZONE 1 | ZONE 2 | ZONE 3 |
|--------------------------------|--------|--------|--------|
| 36 inches and less | 425 \$ | 525 \$ | 625 \$ |
| 36-96 inches | 495 \$ | 595 \$ | 695 \$ |
| Shipping of the brackets first | 50 \$ | 50 \$ | 75 \$ |

Prices for single item orders, for orders of 2 items or more please contact info@balux.ca

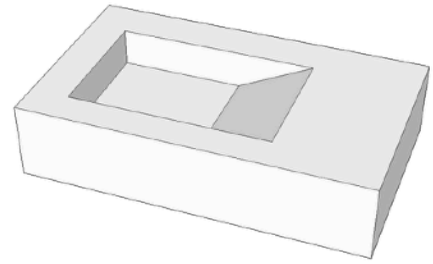

List pricing

| Thickness of facade | | | | | | | | | | |
|---------------------|---|----------|------------|----------|---------------|----------|------------|----------|---------------|----------|
| LENGTH | 1" | | 2" | | 4" | | 6" | | 8" | |
| | Types of finishes (terrazzo = exterior only) | | | | | | | | | |
| | Color | Terrazzo | Color | Terrazzo | Color | Terrazzo | Color | Terrazzo | Color | Terrazzo |
| * 28-36" | 2306 | 2564 | 2392 | 2660 | 2482 | 2760 | 2575 | 2864 | 2672 | 2971 |
| 37"-48" | 2553 | 2839 | 2649 | 2945 | 2748 | 3056 | 2851 | 3170 | 2958 | 3289 |
| 49"-60" | 2680 | 2980 | 2781 | 3092 | 2885 | 3208 | 2993 | 3328 | 3105 | 3453 |
| 61"-72" | 3042 | 3383 | 3156 | 3510 | 3274 | 3641 | 3397 | 3778 | 3525 | 3919 |
| 73"-84" | 3289 | 3657 | 3412 | 3795 | 3540 | 3937 | 3673 | 4084 | 3811 | 4238 |
| 85"-96" | 3537 | 3933 | 3670 | 4081 | 3807 | 4234 | 3950 | 4392 | 4098 | 4557 |
| Approximate weight | 10 lb/sqft | | 12 lb/sqft | | 13,50 lb/sqft | | 18 lb/sqft | | 20,50 lb/sqft | |
| | Take length and depth to calculate square feet. The 2" counter is full of concrete, which explains why it is heavier. For example, a 48' x 21 1/2" counter-sink = 7.17 sqft x 18 lb (6") = 129 lb total | | | | | | | | | |

* smaller size available upon request

STANDARD BASIN OPTION

21" x 13 1/2" x 5"

Validate depth of counter space depending on faucets

| | | | |
|---------------------|--|---------------------|--|
| Wall mounted | Basin 13 1/2" + 2" back + 3 1/2" front = 19" total | Deck mounted | Basin 13 1/2" + 4 1/2" back + 3 1/2" front = 21 1/2" total |
|---------------------|--|---------------------|--|

For any other depth or dimensions please contact us at : info@balux.ca

OPTIONAL

| | | |
|---|---------------|----------------------|
| BRACKETS for floating sinks (UNIT) min. 2 per vanity | BRAQ16 | 105,00 \$ |
| EXTRA BASIN | CUV2 | 300,00 \$ |
| CUSTOM BASIN | CUST | + 50% OF TOTAL PRICE |
| CUSTOM COLOR | 999 | 275,00 \$ |
| FLUTED DESIGN | FLUT | 475,00 \$ |
| RIBBED DESIGN | RIBB | 475,00 \$ |
| ROUND CORNER | ROUND | 250,00\$ EACH |
| SHIPPING PRICE Refer to chart, or contact us info@balux.ca | | |

REQUIRED Net pricing DELIVERY TO THE STORE ONLY

SHIPPING & HANDLING FEES * refer to page 19 for zone information

| SIZE OF ITEM | ZONE 1 | ZONE 2 | ZONE 3 |
|--------------------------------|--------|--------|--------|
| 36 inches and less | 425 \$ | 525 \$ | 625 \$ |
| 36-96 inches | 495 \$ | 595 \$ | 695 \$ |
| Shipping of the brackets first | 50 \$ | 50 \$ | 75 \$ |

Prices for single item orders, for orders of 2 items or more please contact info@balux.ca

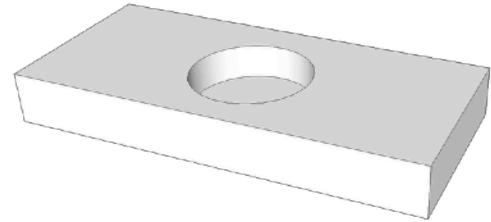

List pricing

| Thickness of facade | | | | | | | | | | |
|---------------------|---|----------|------------|----------|---------------|----------|------------|----------|---------------|----------|
| LENGTH | 1" | | 2" | | 4" | | 6" | | 8" | |
| | Types of finishes (terrazzo = exterior only) | | | | | | | | | |
| | Color | Terrazzo | Color | Terrazzo | Color | Terrazzo | Color | Terrazzo | Color | Terrazzo |
| * 22-36" | 2306 | 2564 | 2392 | 2660 | 2482 | 2760 | 2575 | 2864 | 2672 | 2971 |
| 37"-48" | 2553 | 2839 | 2649 | 2945 | 2748 | 3056 | 2851 | 3170 | 2958 | 3289 |
| 49"-60" | 2680 | 2980 | 2781 | 3092 | 2885 | 3208 | 2993 | 3328 | 3105 | 3453 |
| 61"-72" | 3042 | 3383 | 3156 | 3510 | 3274 | 3641 | 3397 | 3778 | 3525 | 3919 |
| 73"-84" | 3289 | 3657 | 3412 | 3795 | 3540 | 3937 | 3673 | 4084 | 3811 | 4238 |
| 85"-96" | 3537 | 3933 | 3670 | 4081 | 3807 | 4234 | 3950 | 4392 | 4098 | 4557 |
| Approximate weight | 10 lb/sqft | | 12 lb/sqft | | 13,50 lb/sqft | | 18 lb/sqft | | 20,50 lb/sqft | |
| | Take length and depth to calculate square feet. The 2" counter is full of concrete, which explains why it is heavier. For example, a 48' x 21 1/2" counter-sink = 7.17 sqft x 18 lb (6") = 129 lb total | | | | | | | | | |

* smaller size available upon request

STANDARD BASIN OPTION

Diameter: 14" high: 4"

Validate depth of counter space depending on faucets

| | | | |
|--------------|--|--------------|--|
| Wall mounted | Basin 14" + 2" back + 3 1/2" front = 19 1/2" total | Deck mounted | Basin 14" + 4 1/2" back + 3 1/2" front = 22" total |
|--------------|--|--------------|--|

For any other depth or dimensions please contact us at : info@balux.ca

OPTIONAL

| | | |
|--|------------------|----------------------|
| BRACKETS for floating sinks (UNIT) min. 2 per vanity | BRAQ16 | 105,00 \$ |
| EXTRA BASIN | CUV2 | 300,00 \$ |
| CUSTOM BASIN | CUST | + 50% OF TOTAL PRICE |
| CUSTOM COLOR | 999 | 275,00 \$ |
| FLUTED DESIGN | FLUT | 475,00 \$ |
| RIBBED DESIGN | RIBB | 475,00 \$ |
| CONCRETE DRAIN | DRBET-xxx | 295,00 \$ |
| ROUND CORNER | ROUND | 250,00\$ EACH |

SHIPPING PRICE Refer to chart, or contact us info@balux.ca

REQUIRED Net pricing DELIVERY TO THE STORE ONLY

SHIPPING & HANDLING FEES * refer to page 19 for zone information



| SIZE OF ITEM | ZONE 1 | ZONE 2 | ZONE 3 |
|--------------------------------|--------|--------|--------|
| 36 inches and less | 425 \$ | 525 \$ | 625 \$ |
| 36-96 inches | 495 \$ | 595 \$ | 695 \$ |
| Shipping of the brackets first | 50 \$ | 50 \$ | 75 \$ |

Prices for single item orders, for orders of 2 items or more please contact info@balux.ca

VOLTO

List pricing

REFER TO ZONE CHART FOR SHIPPING PRICE

|  | Product code | Product size | Dimension of the basin | Weight | Price | |
|---|-------------------------------|--|-------------------------------------|--------|--------|-------------------------------------|
| | | | | | Color | Terrazzo |
|  | VOL16-xxx | Diameter : 16" External height 5" | Diameter: 15" Internal height 4" | 25 lb | 795 \$ | 1150 \$ *exterior of vessel only |
| | VOL16F-xxx (fluted option) | Diameter 15 3/4" Height 5" | Diameter: 14" Internal height 4" | 30 lb | 1250\$ | Not offered |
| BRACKET SYSTEM | BRAQV | Special brackets for wall mounted installation | | | 210 \$ | |

KANTO

List pricing

REFER TO ZONE CHART FOR SHIPPING PRICE

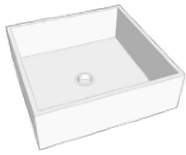
|  | Product code | Product size | Dimension of the basin | Weight | Price | |
|---|----------------|--------------|--|--------|--------|-------------------------------------|
| | | | | | Color | Terrazzo |
|  | KAN16-xxx | 16"X16"X5" | 15"X15"X4" | 35 lb | 795 \$ | 1150 \$ *exterior of vessel only |
| | BRACKET SYSTEM | BRAQK | Special brackets for wall mounted installation | | | 210 \$ |

SHIPPING & HANDLING FEES * refer to page 19 for zone information **Net pricing**

| ZONE 1 | ZONE 2 | ZONE 3 |
|--------|--------|--------|
| 100 \$ | 125 \$ | 150 \$ |



Prices for single item orders, for orders of 2 items or more please contact info@balux.ca

|  | Product code | Product | Price |
|--|--------------|----------------|--------|
| | DRBET-xxx | Concrete drain | 295 \$ |

TALI

List pricing

REFER TO ZONE CHART FOR SHIPPING PRICE

|  | Product code | Product size | Dimension of the basin | Weight | Price | |
|---|--------------|--|------------------------|--------|--------|-------------------------------------|
| | | | | | Color | Terrazzo |
|  | TALI2015-xxx | 20"X15"X5" | 19"X14"X4" | 40 lb | 910 \$ | 1300 \$ *exterior of vessel only |
| BRACKET SYSTEM | BRAQK | Special brackets for wall mounted installation | | | 210 \$ | |

|  | Product code | Product | Price |
|---|--------------|----------------|--------|
| | DRBET-xxx | Concrete drain | 295 \$ |

SHIPPING & HANDLING FEES * refer to page 19 for zone information **Net pricing (Delivery to the store only)**

| ZONE 1 | ZONE 2 | ZONE 3 |
|--------|--------|--------|
| 100 \$ | 125 \$ | 150 \$ |

Prices for single item orders, for orders of 2 items or more please contact info@balux.ca

VICTORIA

List pricing

REFER TO ZONE CHART FOR SHIPPING PRICE

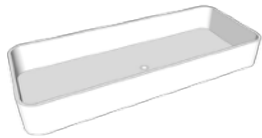
|  | Product code | Product size | Dimension of the basin | Weight | Price | |
|---|--------------|--|------------------------|--------|---------|-------------------------------------|
| | | | | | Color | Terrazzo |
|  | VIC4016-xxx | 40"X16"X5" | 39"X15"X4" | 70 lb | 1620 \$ | 2310 \$ *exterior of vessel only |
| BRACKET SYSTEM | BRAQVIC | Special brackets for wall mounted installation | | | 350 \$ | |

SHIPPING & HANDLING FEES * refer to page 19 for zone information **Net pricing (Delivery to the store only)**



| ZONE 1 | ZONE 2 | ZONE 3 |
|--------|--------|--------|
| 425 \$ | 525 \$ | 625 \$ |

Prices for single item orders, for orders of 2 items or more please contact info@balux.ca

|  | Product code | Product | Price |
|--|--------------|----------------|--------|
| | DRBET-xxx | Concrete drain | 295 \$ |

List pricing

REFER TO ZONE CHART FOR SHIPPING PRICE

|  | Product code | Product size | Dimension of the basin | Weight | Price | |
|---|--------------|--|------------------------|--------|--------|-------------------------------------|
| | | | | | Color | Terrazzo |
|  | LI2215-xxx | 22"X15"X5" | 21"X14"X4" | 40 lb | 975 \$ | 1365 \$ *exterior of vessel only |
| BRACKET SYSTEM | BRAQL | Special brackets for wall mounted installation | | | 210 \$ | |

|  | Product code | Product | Price |
|---|--------------|----------------|--------|
| | DRBET-xxx | Concrete drain | 295 \$ |

SHIPPING & HANDLING FEES * refer to page 19 for zone information **Net pricing (delivery in store only)**

| ZONE 1 | ZONE 2 | ZONE 3 |
|--------|--------|--------|
| 125 \$ | 195 \$ | 225 \$ |

Prices for single item orders, for orders of 2 items or more please contact info@balux.ca

List pricing

REFER TO ZONE CHART FOR SHIPPING PRICE

|  | Product code | Product size | Dimension of the basin | Weight | Price (natural / color) |
|---|--|----------------------------|---------------------------|---------|--------------------------|
|  | CYL3416-xxx | | | 135 lb | 3192 \$ |
| | CYL3416P-xxx (Faucet area) | | | 135 lb | 3442\$ |
| | CYL3416OMB-xxx/ xxx | Height 34" Diameter 16" | Diameter 15" Height 4" | 135 lb | 4692\$ |
| | CYL3416OMBP- xxx/xxx (Faucet area) | | | 135 lb | 4924\$ |
|  | CYL3416RIB-xxx | Height 34" Diameter 16" | Diameter 15" Height 4" | 135 lb | 5200\$ |
| | CYL3416RIBP-xxx | | | 135 lbs | 5450\$ |

List pricing

REFER TO ZONE CHART FOR SHIPPING PRICE

|  | Product code | Dimension | Dimension of the basin | Weight | Price |
|--|---|-------------|------------------------|---------|---------|
| | | | | | Color |
|  | OSL3015-xxx | 30"X15"X34" | 29"X14"X4" | 160 lbs | 3850 \$ |
| | OSL3015P-xxx (Faucet area) | 30"X15"X34" | 29"X14"X4" | 160 lbs | 4100 \$ |
|  | OSLRIB3015-xxx (Ribbed) | 30"X15"X34" | 29"X14"X4" | 160 lbs | 5400 \$ |
| | OSLRIB3015P- xxx (Ribbed with faucet area) | 30"X15"X34" | 29"X14"X4" | 160 lbs | 5650 \$ |

SHIPPING & HANDLING FEES * refer to page 19 for zone information **Net pricing (Delivery to the store only)**

| ZONE 1 | ZONE 2 | ZONE 3 |
|--------|--------|--------|
| 400 \$ | 500 \$ | 600 \$ |







Prices for single item orders, for orders of 2 items or more please contact info@balux.ca

| | | | |
|--|--------------|----------------|--------|
|  | Product code | Product | Price |
| | DRBET-xxx | Concrete drain | 295 \$ |

WALL MOUNTED BASINS

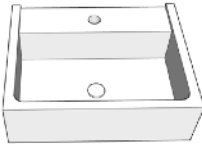
List pricing

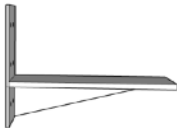
REFER TO ZONE CHART FOR SHIPPING PRICE

|  | Name | Product code | Total dimension | Weight | Price | |
|---|---------|--|-----------------|--------|--------------------|----------------------------|
| | | | | | Color | Terrazzo (Front and sides) |
|  | FERMONT | FERM2010-xxx (COMPATIBLE WITH BRAQ8) | 20" x 10" x 6" | 50 lb | 2185 \$ | 2695 \$ |
|  | YUKON | YUKO2016-xxx (COMPATIBLE WITH BRAQ14) | 20" x 16" x 6" | 75 lb | 2185 \$ | 2695 \$ |
|  | HUDSON | HUDS2414-xxx <i>faucets holes on request (triple or single)</i> (COMPATIBLE WITH BRAQ12) | 24" x 14" x 18" | 85 lb | 2705 \$ | 3335 \$ |
|  | | BRAQ8 | 8" x 3" x 6" | 5 lb | 105\$/ ea (min 2) | |
|  | | BRAQ12 | 12" x 3" x 16" | 10 lb | 105\$ / ea (min 2) | |
|  | | BRAQ14 | 14" x 3 x 6" | 7 lb | 105\$/ ea (min 2) | |

SHIPPING & HANDLING FEES * refer to page 19 for zone information **Net pricing (Delivery to the store only)**



| ZONE 1 | ZONE 2 | ZONE 3 |
|---------------------------------------|--------|--------|
| 425 \$ | 525 \$ | 625 \$ |
| Shipping of the brackets first | | |
| 50 \$ | 50 \$ | 75 \$ |

Prices for single item orders, for orders of 2 items or more please contact info@balux.ca



| | | | |
|---|--------------|----------------|--------|
|  | Product code | Product | Price |
| | DRBET-xxx | Concrete drain | 295 \$ |

List pricing

REFER TO ZONE CHART FOR SHIPPING PRICE

|  | Name | Product code | Dimension | Weight | Price | |
|--|--------|--------------|-----------------------------------|--------|-------|----------|
| | | | | | Color | Terrazzo |
|  | LINEA | BDI3648L-XXX | 47 7/8" X 35 7/8" X 1 1/2" | 160 lb | 2299 | 2552 |
| | | BDI3260L-XXX | 59 7/8" X 31 7/8" X 1 1/2" | 177 lb | 2530 | 2810 |
| | | BDI3660L-XXX | 59 7/8" X 35 7/8" X 1 1/2" | 215 lb | 2838 | 3151 |
| | | BDI4260L-XXX | 59 7/8" X 41 7/8" X 1 1/2" | 230 lb | 3014 | 3350 |
| | | BDI3672L-XXX | 71 7/8" X 35 7/8" X 1 3/4" | 245 lb | 3097 | 3443 |
|  | CENTRO | BDI3648C-XXX | 47 7/8" X 35 7/8" X 1 1/2" | 160 lb | 2299 | 2552 |
| | | BDI3260C-XXX | 59 7/8" X 31 7/8" X 1 1/2" | 177 lb | 2530 | 2810 |
| | | BDI3660C-XXX | 59 7/8" X 35 7/8" X 1 1/2" | 215 lb | 2838 | 3151 |
| | | BDI4260C-XXX | 59 7/8" X 41 7/8" X 1 1/2" | 230 lb | 3014 | 3350 |
| | | BDI3672C-XXX | 71 7/8" X 35 7/8" X 1 1/2" | 245 lb | 3097 | 3443 |

CHOOSE DRAIN OPTION FOR THE LINEA MODEL
 THE CENTRO SHOWER BASE COMES AUTOMATICALLY WITH THE SQUARE CONCRETE DRAIN COVER.

| | | | | |
|---|---------|--|---------|--------|
|  | D-STAIN | Size varies depending on the shower base | n.d | 0 \$ |
|  | D-BLACK | Size varies depending on the shower base | n.d | 250 \$ |
|  | DC-BET | 6"X6" X 5/8" | 1,50 lb | 0 \$ |

SHIPPING & HANDLING FEES * refer to page 19 for zone information **Net pricing (Delivery to the store only)**







| ZONE 1 | ZONE 2 | ZONE 3 |
|--------|--------|--------|
| 400 \$ | 500 \$ | 600 \$ |

Prices for single item orders, for orders of 2 items or more please contact info@balux.ca

BATHTUBS

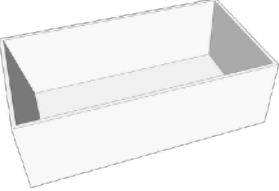
List pricing

REFER TO ZONE FOR SHIPPING PRICE

|  BALUX | Name | Product code | Dimension | Weight | Color |
|---|-------------------------|---------------|------------------------------|--------|-----------|
|  * Organic finish on the exterior | KOPA | KOPA65-xxx | Diameter 65" High 22 1/2" | 450 lb | 13 700 \$ |
| | | KOPA55-xxx | Diameter 55" High 22 1/2" | 400 lb | 12 100 \$ |
|  * Organic finish on the exterior | OLÁ | OLA6236-xxx | 62" x 36 x 21" | 515 lb | 10 450 \$ |
| | | OLA6636-xxx | 66" x 36" x 21" | 525 lb | 10 615 \$ |
| | OLÁ <i>petite</i> | OLA7236-xxx | 72" x 36" x 21" | 585 lb | 11 275 \$ |
| | | OLA6030-xxx | 60"x30" x21" | 380 lb | 8 900 \$ |
|  | BREK | BREK6636-xxx | 66" x 36" x 21" | 670 lb | 10 615 \$ |
| | | BREK7236- xxx | 72" x 36" x 21" | 700 lb | 11 275 \$ |
|  | JASPER (Soaking tub) | JASP5928-xxx | 59 1/2" x 28" x 25" | 700 lb | 10 615 \$ |
|  * Organic finish on the exterior | AMARI | AMAR6635-xxx | 66" x 35 " x 21" | 525 lb | 13 700\$ |
|  * Organic finish on the exterior | TOSCANE | TOS6635-xxx | 66" x 35" x 21" | 525 lb | 16 500\$ |

BATHTUBS

List pricing

REFER TO ZONE FOR SHIPPING PRICE

|  BALUX | Name | Product code | Dimension | Weight | Color |
|---|--------|--------------|-----------------------------|--------|-----------|
|  * Organic finish on the exterior | AZUR | AZU6531-xxx | 65" x 31" x 22" | 500 lb | 13 115 \$ |
|  * Organic finish on the exterior | MONACO | MONA5928-xxx | 59 3/4" x 28 1/2" x 21 1/2" | 350 lb | 8 900\$ |
|  * Organic finish on the exterior | ASPEN | ASP7030-xxx | 70" x 30" x 22" | 500 lb | 12 950 \$ |
|  * Organic finish on the exterior | CAPRI | CAP7232-xxx | 72" x 32" x 21" | 450 lb | 11 275\$ |
|  * Organic finish on the exterior | BANFF | BAN6528-xxx | 65" x 28" x 21 1/2" | 550 lb | 12 500\$ |
|  * Organic finish on the exterior | MILAN | MILA6032-xxx | 60" x 32" x 26" | 450 lb | 16 700\$ |

BATHTUBS

List pricing

REFER TO ZONE FOR SHIPPING PRICE

|  | Name | Product code | Dimension | Weight | Color |
|---|-----------------------|--------------|-----------------------------|--------|-----------|
|  | SAKAMI | SAKA4240-xxx | Diameter 42" Height 40" | 515 lb | 13 700\$ |
|  | TAÕ | TAO5236-xxx | 52" x 36 1/2" x 34" | 450 lb | 13 700\$ |
|  | TOFINO (end drain) | TOFI6527-xxx | 64"x 32" x 22 1/4" | 650 lb | 10 615 \$ |
| OPTION DE DRAIN | | | | | |
|  | MATTE BLACK DRAIN | DRMB | See manufacturer details | | 175 \$ |
|  | CHROME DRAIN | DRCPB | See manufacturer details | | 175 \$ |
|  | CONCRETE DRAIN | DRBET3-xxx | See manufacturer details | | 395 \$ |

SHIPPING & HANDLING FEES * refer to page 19 for zone information **Net pricing (Delivery to the store only)**

| ZONE 1 | ZONE 2 | ZONE 3 |
|--|--------|--------|
| 450 \$ | 550 \$ | 650 \$ |
| Prices for single item orders, for orders of 2 items or more please contact info@balux.ca | | |

OTHER PRODUCTS

List pricing

| PRODUCTS | PRODUCT CODE | DIMENSION | WEIGHT | PRICE (per unit) | |
|----------------------------------|--------------|------------------|---------------|-------------------|--------------------|
| | | | | Color | Terrazzo |
| SEALED TILES (Floor and wall) | TS2424-xxx | 24"x24"x 5/8" | 24,50 lb | 89.60\$ | 99.60\$ |
| | TS2448-xxx | 24" x 48" x 5/8" | 49 lb | 196.80\$ | 218.40\$ |
| | TS4848-xxx | 48"x 48" x 5/8" | 98 lb | 477.60\$ | 530.40\$ |
| | N.A | Custom size | 6.11 lb/sqft | 36,10 \$ /sqft | 40,15 \$ /sqft |
| COUNTERTOPS | N.A | Thickness 1" | 12,22 lb/sqft | 135\$ / sqft | 175\$ / sqft |
| BACKSPLASH | N.A | Thickness 5/8" | 6.11 lb/sqft | 200\$ + 95\$/sqft | 200\$ + 135\$/sqft |

| PRODUCTS | PRODUCT CODE | DIMENSION | WEIGHT | PRICE | |
|---------------------------------|--------------|------------------|----------------|----------------------------------|-------------------|
| | | | | Regular finish | Industrial finish |
| WALL TILES (Unsealed) | WP2448-xxx | 24" x 48" x 5/8" | 49 lb | 158.00\$ ea | 158.00\$ ea |
| | WP4848-xxx | 48"x 48" x 5/8" | 98 lb | 396.00\$ ea | 396.00\$ ea |
| | N.A | Custom size | 6.11 lb / sqft | 30,65\$/ sqft | 30,65\$/ sqft |
| WALL TILES (Form Hole) | FHWP2448-xxx | 24" x 48" x 5/8" | 49 lb | 158.00\$ ea | 158.00\$ ea |
| | FHWP4848-xxx | 48" x 48" x 5/8" | 98 lb | 396.00\$ ea | 396.00\$ ea |
| Option for Form Hole wall panel | WPBolt | N.A | N.A | Price to be confirmed with Balux | |

| PRODUCTS | PRODUCT CODE | DIMENSION | WEIGHT | PRICE |
|---------------------------|--------------|------------------|--------|----------|
| FLUTED PANELS (SEALED) | FP2448-xxx | 24"x48"x3/4" | 74 lb | 280\$ ea |
| RIBBED PANELS (SEALED) | RIB2448-xxx | 24" x 48" x 5/8" | 49 lb | 280\$ ea |

| PRODUCTS | PRODUCT CODE | DESCRIPTION | PRICE |
|--------------------------|--------------|--|----------|
| MAINTENANCE (Net price) | CLEAN50 | Duo of a daily and weekly cleaning product | 50,00 \$ |
| | SEAL50 | Clear sealer | 50,00 \$ |

| | | |
|--|---------------|---------------|
| ZONE 1 | ZONE 2 | ZONE 3 |
| Please contact info@balux.ca to confirm SHIPPING AND HANDLING FEES Net pricing | | |

COLORS

2025



Terracotta
007



Leather
008



Merlot
009



Moka
010



Bark
011



Sage
012



White
001



Pearl
002



Ash
003

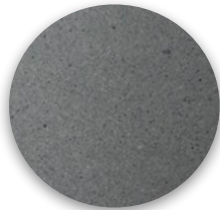

Dark grey
004



Charcoal
005



Black
006



Bone
013



Linen
103



Sand
014



Mango
102



Blush
101



Lilac
015

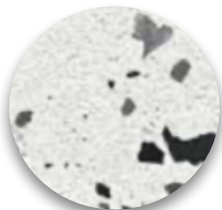

Terrazzo
Bianco
T01

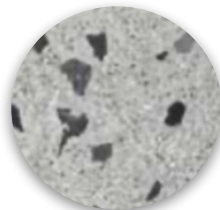

Terrazzo
Grigio
T02

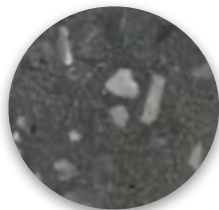

Terrazzo
Nero
T05



COLORS

TERRA PRECIOSA



Snow-CR-SO



Snow-CRS-CRL-57



Rainfall-KH-SO

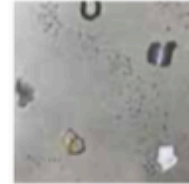

Rainfall-57



Charcoal-OBLK-SO



Charcoal-57

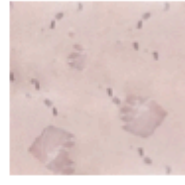

Blush-57

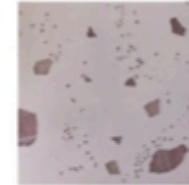

Lilac-57

* Other arrangements are possible upon request.

The steel brackets system goes on the 2x4 behind the drywall. They must be installed before closing the walls.

An installation plan will be sent to the customer with the instructions since installation may vary depending on the dimension of the vanity and the position of the basin.

Usually 2 brackets are required. If the counter is longer than 96 inches, you must use 3 brackets.

The brackets must be installed on the left and right sides of the basin centered in the empty counter spaces. You must always leave a 1 inch space from each external sides and 1 inch away from the basin. A minimum of 4 inches is required on both sides of the basin to allow sufficient space for the brackets.

Usually floating vanities are installed at a height between 34 inches and 36 inches from the floor.

The back of the vanity is 1 inch thick. The arms of the brackets need to be installed 1 inch lower than the final height required.

After the installation of the steel bracket system, the wall is ready to be closed.

When you will received the concrete vanity, you only need to put some silicone on the arms and place the sink on top of the silicone.

Adjustments to level the sink may be needed once it's sitting on top of the brackets.

We suggest to apply silicone at the junction of the counter and the wall to ensure maximum tightness and solidity.

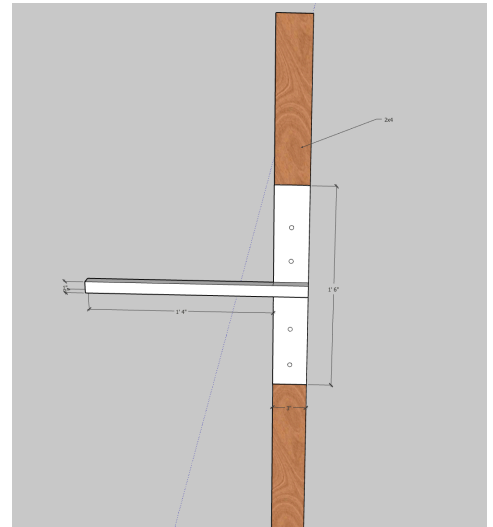

Bracket direction on the 2x4



Deposit the vanity on the bracket



Suggested type of silicone



WARRANTY

- ✦ BALUX Inc products are guaranteed for a period of five (5) years from the date of purchase, with respect to manufacturing defects. This warranty does not cover breakage during installation, improper installation, scratches, normal wear and tear that may occur over time and the sealer that is applied to the product. The warranty is limited to repairs, replacement or reimbursement of defective products at our discretion, excluding the installation and transport fees of the replaced product.
- ✦ It may happen that there are slight variations in color, dimensions, veins, micro hairline cracks, holes and stains in the products. This uncontrollable and natural phenomenon cannot be considered as a defect and in no way diminishes the quality of the products. Some variations can be caused by different admixtures in the concrete or other natural impurities that may be found inside our material. PLEASE REFER TO PAGE <https://www.balux.ca/general-8> ON OUR WEBSITE TO SEE AND UNDERSTAND THE DIFFERENT NATURAL CHARACTERISTICS OF CONCRETE.
- ✦ The product must be inspected thoroughly when it is received and this before the departure of the carrier. If a breakage occurred during transport, it must absolutely be mentioned to the driver, and indicated on the reception document. Photos must be taken of the damaged product while still on the pallet **(not once installed)** and also the condition of the pallet and contact Balux within 24hrs.
- ✦ All pieces fabricated and listed on the invoice cannot be returned and/or refunded.

Thank you for your trust,

BALUX inc.

If you have any questions, do not hesitate to contact us at 450-578-0210, or by email info@balux.ca



BALUX

CONTACT

GENERAL OR TECHNICAL INQUIRY

Contact : Krystel Blanchette
Tel: 438-401-8267 ext. 101
Email: info@balux.ca

TO PLACE AN ORDER:

orders@balux.ca

INQUIRY FOR DELIVERIES, ORDER FOLLOW UP AND PRODUCTION DELAYS.

Contact : Naomie Brouillard
Tel: 438-401-8267 ext. 102
Email: shipping@balux.ca

Contact: Renelle Brouillard
Tel: 438-401-8267 ext. 103
Email: renelle@balux.ca

Customer service :
service@balux.ca

ACCOUNTING

Email: payables@balux.ca



THE ENDLESS POSSIBILITIES OF CONCRETE